

Tandem valve, welded valve configuration

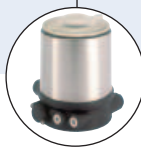

- Fully integrated in Burkert's Process Control Systems
- Quality certifications

Type 2034 can be combined with...



Type 8691
Control Head

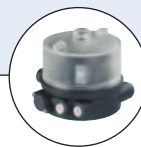

Type 8690
Pneum. control unit with feedback



Type 8692
Positioner Top-Control continuous



Stroke limitation
Min./max. stroke limitation

The Bürkert welded valve configurations for SAP (sterile access port) and GMP (good manufacturing practice) are designed for the control of ultrapure, sterile, aggressive or abrasive fluids. The configurations are made from two separate forged valve bodies. They are welded to be fully drainable and can be operated by either pneumatic actuator or manual handwheel.

The user can choose the required configuration in two separated specification keys. The first details the geometry, body and diaphragm materials while the second specifies body sizes, end connections, operator and surface finishes.



Available accessories include Positioner/PID controllers, stroke limiters, electrical feedback, pneumatic pilot valves.

Technical data											
Orifice	DN08 to DN100										
Body material	<ul style="list-style-type: none"> ▪ Stainless steel 1.4435 acc. to BN2 / ASME BPE, Fe < 0.5% ▪ Other on request 										
Port connections	<ul style="list-style-type: none"> ▪ DIN EN ISO 1127 / ISO 4200 / DIN 11866 Serie B ▪ DIN 11850 Serie 2 / DIN 11866 Serie A ▪ ASME BPE / DIN 11866 Serie C ▪ DIN 32676 Serie A (DIN tube) ▪ DIN 32676 Serie B (ISO tube) ▪ ASME BPE 										
Weld end											
Clamp											
Surface finish	<table border="1"> <tr> <td>Ra [µm]</td> <td>Ra [µInch]</td> </tr> <tr> <td>internal</td> <td>internal</td> </tr> <tr> <td>Mechanical polished</td> <td>25</td> </tr> <tr> <td>Electro polished</td> <td>15</td> </tr> <tr> <td>Other on request</td> <td>Other on request</td> </tr> </table>	Ra [µm]	Ra [µInch]	internal	internal	Mechanical polished	25	Electro polished	15	Other on request	Other on request
Ra [µm]	Ra [µInch]										
internal	internal										
Mechanical polished	25										
Electro polished	15										
Other on request	Other on request										
Seal materials	EPDM, PTFE/EPDM, advanced PTFE/EPDM, FKM										
Actuator material	<ul style="list-style-type: none"> Element (DN08-50) PPS, cover in Stainless steel 1.4561 (316Ti) Classic (DN65-100) PA, socle in Stainless steel 1.4308 Manual PPS/PPS, PPS/St. steel (DN65, 80, 100 in full stainless steel) 										
Pilot air ports	G 1/8" or Push-In										
Media temperature	<ul style="list-style-type: none"> EPDM (AD) -5 to +143°C (SIP: up to +150°C, 60 min.) advanced PTFE/EPDM (EU)¹⁾ -10 to +130°C (SIP: up to +140°C, 60 min.) advanced PTFE laminated on EPDM (EK)²⁾ +5 to +90°C (no steam) 										
Ambient temperature	+5 to +60°C										
Control medium	Neutral gases, air										
Installation for self-draining	See configuration option on page 5										



¹⁾ Advanced PTFE/EPDM is recommended for sterilization cycle

Technical data, *continued*

Pneumatic actuator

	Port connection DN		Orifice (diaphragm size) [mm]	Actuator size Ø [mm]	Permitted pilot pressure [bar]		Max. operating pressure for seal material [bar]	
	[mm]	[inch]			min.	max.	EPDM, FKM	PTFE/EPDM and advanced PTFE/EPDM
ELEMENT 	8	1/4"	8	50	5	10	10	10
	10	3/8"	8	50	5	10	10	10
	15	1/2"	15	70	5	10	10	10
	20	3/4"	20	70	5	10	10	10
	25	1"	25	70	5	10	6.5	6
				90	5.5	10	10	8
	40	1 1/2"	40	130	5	7	10	10
50	2"	50	130	5	7	8	7	
Classic 	65	2 1/2"	50 or 80	125	5.5	7	8	7
			225	5	6	10	10	
	80	3"	80	225	5	6	10	10
	100	4"	100	225	5	6	8	4

Manual actuator

	Port connection DN		Orifice (diaphragm size) [mm]	Max. operating pressure for seal material [bar]	
	[mm]	[inch]		EPDM, FKM	PTFE/EPDM and advanced PTFE/EPDM
	8	1/4"	8	10	10
	10	3/8"	8	10	10
	15	1/2"	15	10	10
	20	3/4"	20	10	10
	25	1"	25	10	10
	40	1 1/2"	40	10	10
	50	2"	50	7/10	7/10
	65	2 1/2"	50 or 80	5/7/10	5/7/10
	80	3"	80	5	5
	100	4"	100	5	5

Pressure values (bar)

Gauge pressures with respect to the prevailing atmospheric pressure.

Remark:

For low operating pressures we recommend reduced spring force versions to prolong the life of the diaphragm

Materials

Pneumatic

ELEMENT actuator DN08- DN50

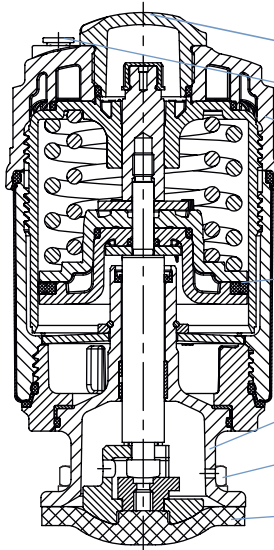

Optical position indicator	Transparent cap polysulfone PSU
Pilot air ports	Push-in connector PP (standard) <i>on request: Thread 1/8" stainless steel 1.4305</i>
Actuator cover	PPS
Cover	Stainless steel 1.4561 (316Ti)
Piston seal	FKM
Socle	Stainless steel 1.4308
Screws	Stainless steel
Diaphragm	EPDM, PTFE/EPDM <i>(advanced PTFE/EPDM, FKM on request)</i>

Classic actuator DN65- DN100

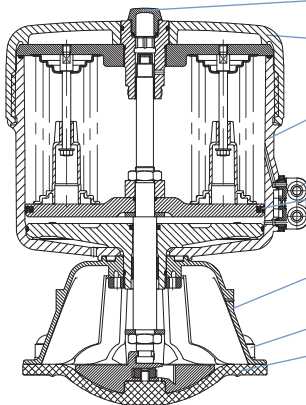

Optical position indicator	Transparent cap polycarbonate PC
Actuator	PA Polyamide
Pilot air ports	Thread 1/8" stainless steel 1.4305
Piston seal	NBR
Socle	Stainless steel 1.4308
Screws	Stainless steel
Diaphragm	EPDM, PTFE/EPDM <i>(advanced PTFE/EPDM, FKM on request)</i>

Manual

Manual actuator DN08 - DN100

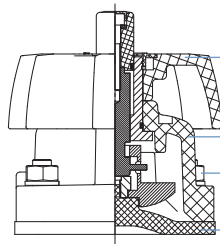

Handwheel	PPS or 316L stainless steel*
Socle	PPS or 316L stainless steel*
Screws	Stainless steel
Diaphragm	EPDM, PTFE/EPDM advanced PTFE/EPDM

* DN65 to DN100 only in stainless steel

Approvals/certifications

- Certification of Conformity for Raw Material EN-ISO 10204 3.1
- Attestation of compliance with the order EN-ISO 10204 2.1
- Test report EN-ISO 10204 2.2
- Certification of Conformity for Pickling and Electropolishing Processes
- Certification of Conformity for the Surface Quality DIN4762-DIN4768-ISO/4287/1
- Certification for the fulfillment of FDA CFR No. 21.177.1550 for PTFE/EPDM and advanced PTFE/EPDM and 21.177.2600 for EPDM
- USP CLASS VI certification for EPDM and PTFE diaphragm
- Test Certification and Conformity Certification for the Final Assembly of Diaphragm Valves
- ISO 9001 Certification

Note: Retrospective manufacturing certification for process diaphragm valves can not be made, therefore please notify when ordering.

Example of available diaphragm materials

Developed to handle the unique challenges of hygienic and sterile applications, Bürkert offers diaphragms with precise material formula and physical tolerances. Bürkert diaphragms are available in a wide range of materials which have been proven in food & beverage, biotechnology, pharmaceutical and cosmetic industry applications. Diaphragms are tested during development and production to ensure reliability in critical processing environments.



- EPDM
- PTFE/EPDM
- advanced PTFE/EPDM
- FKM

Valve features, specification key 1

Example

2034	W	02	03	Z	X	VS	AB	25	GMP2
------	---	----	----	---	---	----	----	----	------

Specification key 1

(Please make a choice)

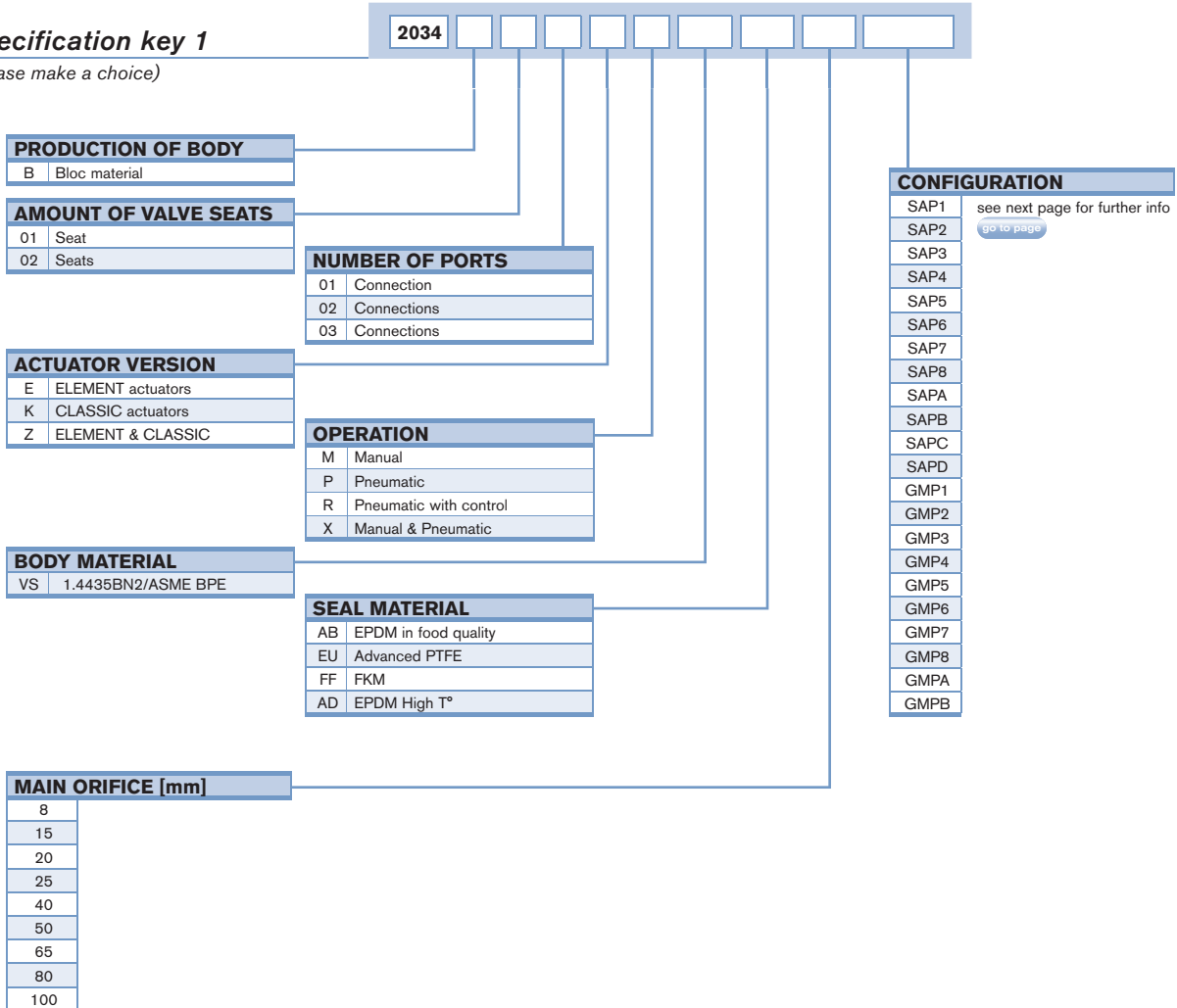

Configurations

Steril access port

SAP1	SAP2	SAP3	SAP4
SAP5	SAP6	SAP7	SAP8
SAPA	SAPB	SAPC	SAPD

Good manufacturing practice

GMP1	GMP2	GMP3	GMP4
GMP5	GMP6	GMP7	GMP8
GMPA	GMPB		

DTS 1000106223 EN Version: F Status: RL (released | freigegeben | validé) printed: 18.03.2015

Valve features, specification key 2

Example

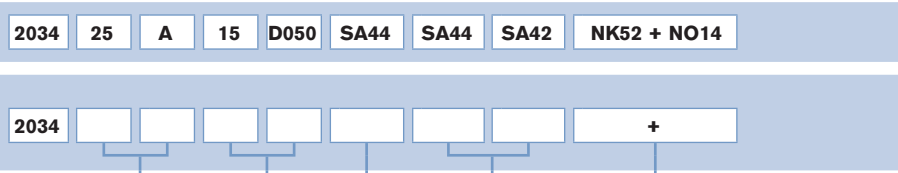

Specification key 2

(Please make a choice)

VALVE/SEAT n°1	
Orifice DN [mm]	Actuator version
08	Pneumatic
15	A normally closed by spring action
20	B normally open by spring action
25	I double acting
40	Manual
50	D050 Handwheel PPS / bonnet PPS
80	D052 Handwheel stainless steel / bonnet stainless steel (only DN65-DN100)
100	D058 Handwheel PPS / bonnet stainless steel with hole for bolts

VALVE/SEAT n°2	
Orifice DN [mm]	Actuator version
08	Pneumatic
15	A normally closed by spring action
20	B normally open by spring action
25	I double acting
40	Manual
50	D050 Handwheel PPS / bonnet PPS
80	D052 Handwheel stainless steel / bonnet stainless steel (only DN65-DN100)
100	D058 Handwheel PPS / bonnet stainless steel with hole for bolts

VARIABLE CODES	
Surface finish, external	
NO22	glass bead blasted Ra=3.2 µm
NO34	Mechanical polished Ra=1.2 µm
NO15	Electro polished Ra=0.8 µm
Surface finish, internal	
NO23	Mechanical polished Ra=0.6µm
NO16	Electro polished Ra=0.6µm
NO14	Mechanical polished Ra=0.5µm
NO17	Elektropoliert Ra=0.4µm
Certificat	
NK52	3.1 Certificate integrated

Port connection Valve/seat n°1

Port connection Valve/seat n°2, 3

DN [mm]	Port connection weld end							
	EN ISO 1127/ ISO 4200 DIN 11866 S. B	SMS 3008	DIN 11850 S. 0	DIN 11850 S. 1	DIN 11850 S. 2 DIN 11866 S. A	DIN 11850 S. 3	BS4825	ASME BPE DIN 11866 S. C
4			SC40 - 6.0x1.0					
6	SA78 - 10.2x1.6		SC41 - 8.0x1.0					SA89 - 3.17x0.56
8	SA40 - 13.5x1.6		SC42 - 10.0x1.0				SODB - 6.35x1.2	SA90 - 6.35x0.89
10	SA41 - 17.2x1.6			SF40 - 12.0x1.0	SD40 - 13.0x1.5	SE40 - 14.0x2.0	SODC - 9.53x1.2	SA91 - 9.53x0.89
15	SA42 - 21.3x1.6	SA58 - 12.0x1.0	SC43 - 18.0x1.5	SF41 - 18.0x1.0	SD42 - 19.0x1.5	SE42 - 20.0x2.0	SODD - 12.7x1.2	SA92 - 12.7x1.65
20	SA43 - 26.9x1.6	SA59 - 18.0x1.0	SC44 - 22.0x1.5	SF42 - 22.0x1.0	SD43 - 23.0x1.5	SE43 - 24.0x2.0	SODE - 19.05x1.2	SA93 - 19.05x1.65
25	SA44 - 33.7x2.0	SA60 - 25.0x1.2	SC45 - 28.0x1.5	SF43 - 28.0x1.0	SD44 - 29.0x1.5	SE44 - 30.0x2.0		SODF - 25.4x1.65
32	SA45 - 42.4x2.0	SA61 - 33.7x1.2	SC46 - 34.0x1.5	SF44 - 34.0x1.0	SD45 - 35.0x1.5	SE45 - 36.0x2.0		
40	SA46 - 48.3x2.0	SA62 - 38.0x1.2	SC47 - 40.0x1.5	SF45 - 40.0x1.0	SD46 - 41.0x1.5	SE46 - 42.0x2.0		SODH - 38.1x1.65
50	SA47 - 60.3x2.0	SA63 - 51.0x1.2	SC48 - 52.0x1.5	SF46 - 52.0x1.0	SD47 - 53.0x1.5	SE47 - 54.0x2.0		SODI - 50.8x1.65
65	SA48 - 76.1x2.0	SA64 - 63.5x1.6			SD48 - 70.0x2.0			SODJ - 63.5x1.65
80	SA49 - 88.9x2.3	SA65 - 76.1x1.6			SD49 - 85.0x2.0			SODK - 76.2x1.65
100	SA39 - 114.3x2.3	SA66 - 101.6x2.0			SD50 - 104.0x2.0			SODL - 101.6x2.11

DN [mm]	Port connection Clamp				
	Clamp 34,0 like DIN 32676 S. B (ISO-tube (ISO4200))	DIN 32676 S. A (DIN-tube (DIN11850))	DIN 32676 S. B (ISO-tube (ISO4200))	ASME BPE	BS 4825 (Clamp BS 4825-3, tube BS 4825-1)
8	TC51 - 13.5x1.6 Ci: 34.0	TD40 - 10.0x1.0 Ci: 25.0	TC40 - 13.5x1.6 Ci: 25.0	TG50 - 6.35x0.89 Ci: 25.0	
10	TC41 - 17.2x1.6 Ci: 34.0	TD41 - 13.0x1.5 Ci: 34.0	TC53 - 17.2x1.6 Ci: 25.0	TG01 - 9.53x0.89 Ci: 25.0	
15	TC42 - 21.3x1.6 Ci: 34.0	TD42 - 19.0x1.5 Ci: 34.0	TC52 - 21.3x1.6 Ci: 50.5	TG02 - 12.7x1.65 Ci: 25.0	TH42 - 12.7x1.2 Ci: 25.0
20		TD43 - 23.0x1.5 Ci: 34.0	TC43 - 26.9x1.6 Ci: 50.5	TG03 - 19.05x1.65 Ci: 25.0	TH43 - 19.05x1.2 Ci: 25.0
25		TD44 - 29.0x1.5 Ci: 50.5	TC44 - 33.7x2.0 Ci: 50.5	TG04 - 25.4x1.65 Ci: 50.5	
32					
40		TD46 - 41.0x1.5 Ci: 50.5	TC46 - 48.3x2.0 Ci: 64.0	TG05 - 38.1x1.65 Ci: 50.5	
50		TD47 - 53.0x1.5 Ci: 64.0	TC47 - 60.3x2.0 Ci: 77.5	TG06 - 50.8x1.65 Ci: 64.0	
65			TC48 - 76.1x2.0 Ci: 91.0	TG07 - 63.5x1.65 Ci: 77.5	
80			TC49 - 88.9x2.3 Ci: 106.0	TG08 - 76.2x1.65 Ci: 91.0	
100			TC50 - 114.3x2.3 Ci: 130.0	TG09 - 101.6x2.11 Ci: 119.0	

Note
You can fill out the fields directly in the PDF file before printing out the form.

Standard configuration – request for quotation

▶ Please fill out and send to your nearest Bürkert facility* with your inquiry or order

Company	Contact person
Customer no.	Department
Address	Tel./Fax
Postcode/town	E-Mail

= mandatory fields to fill out Quantity Required delivery date

Operating data

<input type="checkbox"/> Process medium	<input type="text"/>	
<input type="checkbox"/> Type of media	<input type="checkbox"/> Liquid	<input type="checkbox"/> Steam <input type="checkbox"/> Gas
	Nominal	Unit
<input type="checkbox"/> Flow rate (Q, QN, W) ¹⁾	<input type="text"/>	<input type="text"/>
<input type="checkbox"/> Temperature at valve inlet	<input type="text"/>	<input type="text"/>
<input type="checkbox"/> Absolute pressure at valve inlet	<input type="text"/>	<input type="text"/>
<input type="checkbox"/> Absolute pressure at valve outlet	<input type="text"/>	<input type="text"/>
Steam pressure Pv	<input type="text"/>	<input type="text"/>

¹⁾ standard unit:
Liquid Q = m³/h;
Steam W = kg/h;
Gas Qn = nm³/h

Valve features

Specification key 1

2034

(automatically transferred from p 4)

Specification key 2

2034

+

(automatically transferred from p. 6)

Accessories

Click on the orange box „More info.“ below... you will come to our website for the resp. product where you can download the datasheet.

Pilot valve

Type 6012

More info.

Please specify item no. (if known):

for actuator (A1, A2,...)

Stroke limitation

More info.

- Min./max. stroke limitation, with visual position indicator
- Max. stroke limitation, without visual position indicator

Please specify item no. (if known):

for actuator (A1, A2,...)

Position feedback/Control head

- Type 8690
- Type 8691
- Type 8695
- Type 8697
- Type 8685
- Type 8686

More info.

More info.

More info.

More info.

More info.

Please specify item no. (if known):

for actuator (A1, A2,...)

Certifications

- Attestation of compliance with the order EN-ISO 10204 2.1
- Test report EN-ISO 10204 2.2
- Certification of Conformity for Raw Material EN-ISO 10204 3.1
- Certification of Conformity for the Surface Quality DIN4762-DIN4768-ISO/4287/1
- Certification of Conformity for Pickling and Electropolishing Processes
- FDA and USP compliance

Customized configuration – request for quotation

▶ Please fill out and send to your nearest Bürkert facility* with your inquiry or order

Company	Contact person
Customer no.	Department
Address	Tel./Fax
Postcode/town	E-Mail



Weld solution

Sales data

Project name: _____

Quantities: _____ single enquiry
 enquiry for series

Flow schematic

Warning: connection and valve description should be in accordance with the table that filled below!

Please sketch the schematic

Legende

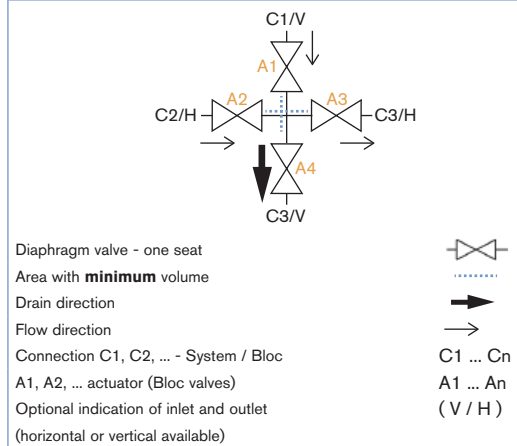

Technical data -Fluidic

Medium nature	_____	Medium pressure	_____
Medium temperature	_____	Medium viscosity	_____
Kv value or flow rate	_____	<input checked="" type="checkbox"/> Bürkert standard in blue	
Material for the bloc	<input checked="" type="checkbox"/> 1.4535 / 316L	<input type="checkbox"/> 1.4435 acc.to BN2 / ASME BPE	Specific material: _____
Surface finish (internal)	<input type="checkbox"/> 0.8 <input checked="" type="checkbox"/> 0.6 <input type="checkbox"/> 0.4 <input type="checkbox"/> 0.25		Specific surface finish (Ra in µm): _____
	<input type="checkbox"/> Electropolish		_____
Surface finish (external)	<input checked="" type="checkbox"/> 1.6		Specific surface finish (Ra in µm): _____
Diaphragm material	<input checked="" type="checkbox"/> EPDM <input type="checkbox"/> PTFE <input type="checkbox"/> FKM		_____

Connection definition

Nominal size C-Nr.	DN	Weld end			Clamp			Divers
		DIN 11850 S2 DIN 11866 SA	ISO 4200 EN ISO 1127 DIN 11866 SB	ASME BPE DIN 11866 SC	DIN 32676 S.A	DIN 32676 S.B	ASME BPE	
C1	_____	<input type="checkbox"/>	<input type="checkbox"/>	<input type="checkbox"/>	<input type="checkbox"/>	<input type="checkbox"/>	<input type="checkbox"/>	_____
C2	_____	<input type="checkbox"/>	<input type="checkbox"/>	<input type="checkbox"/>	<input type="checkbox"/>	<input type="checkbox"/>	<input type="checkbox"/>	_____
C3	_____	<input type="checkbox"/>	<input type="checkbox"/>	<input type="checkbox"/>	<input type="checkbox"/>	<input type="checkbox"/>	<input type="checkbox"/>	_____
C4	_____	<input type="checkbox"/>	<input type="checkbox"/>	<input type="checkbox"/>	<input type="checkbox"/>	<input type="checkbox"/>	<input type="checkbox"/>	_____
C5	_____	<input type="checkbox"/>	<input type="checkbox"/>	<input type="checkbox"/>	<input type="checkbox"/>	<input type="checkbox"/>	<input type="checkbox"/>	_____
C6	_____	<input type="checkbox"/>	<input type="checkbox"/>	<input type="checkbox"/>	<input type="checkbox"/>	<input type="checkbox"/>	<input type="checkbox"/>	_____
C7	_____	<input type="checkbox"/>	<input type="checkbox"/>	<input type="checkbox"/>	<input type="checkbox"/>	<input type="checkbox"/>	<input type="checkbox"/>	_____
C8	_____	<input type="checkbox"/>	<input type="checkbox"/>	<input type="checkbox"/>	<input type="checkbox"/>	<input type="checkbox"/>	<input type="checkbox"/>	_____

Actuator and actuation see specification on next page.

Customized configuration – request for quotation, *continued*

Automation system (product overview)

ELEMENT actuator system

- compact stainless steel design
- designed for modular actuation
- fresh air system

ELEMENT control head Type 8691

- integrated pilot valve
- position teach in
- large LED indication
- ASI and device net communication possible

ELEMENT control head Type 8695 for actuator 50mm

- integrated pilot valve
- position teach in
- large LED indication
- ASI and device net communication possible

ELEMENT feedback head Type 8690 / 8697

- mechanical electrical feedback
- inductive feedback
- Exei version



Description fluidic system Type 2034
 Detail information on www.burkert.com

Technical data - Actuation

Pilot pressure _____ Bürkert standard in blue

Ambient temperature _____

Cycle per year _____

Implementation (clean room, outside...) _____

Hazardous location (EX / ATEX / NAMUR) _____

Actuator material St. steel/Plastic Plastic

Power supply 8 V Namur 24 V/DC 230 V/50-60 Hz

IP protection IP65 IP67

Automation ASI DeviceNet

Remarks: _____

Other actuator material _____

Other protection / application conditions _____

Other power supply _____

Other automation (PLC / Fieldbus) _____

Definition actuation, feedback, pilote valves control head

Nominal size A-Nr. DN	Actuator		Control feedback		Control head + Pilot valve	Control function	
	Pneumatic	Manual	Position ON	Position OFF		normally closed	normally open
A1	<input type="checkbox"/>	<input type="checkbox"/>	<input type="checkbox"/>	<input type="checkbox"/>	<input type="checkbox"/>	<input type="checkbox"/>	<input type="checkbox"/>
A2	<input type="checkbox"/>	<input type="checkbox"/>	<input type="checkbox"/>	<input type="checkbox"/>	<input type="checkbox"/>	<input type="checkbox"/>	<input type="checkbox"/>
A3	<input type="checkbox"/>	<input type="checkbox"/>	<input type="checkbox"/>	<input type="checkbox"/>	<input type="checkbox"/>	<input type="checkbox"/>	<input type="checkbox"/>
A4	<input type="checkbox"/>	<input type="checkbox"/>	<input type="checkbox"/>	<input type="checkbox"/>	<input type="checkbox"/>	<input type="checkbox"/>	<input type="checkbox"/>
A5	<input type="checkbox"/>	<input type="checkbox"/>	<input type="checkbox"/>	<input type="checkbox"/>	<input type="checkbox"/>	<input type="checkbox"/>	<input type="checkbox"/>
A6	<input type="checkbox"/>	<input type="checkbox"/>	<input type="checkbox"/>	<input type="checkbox"/>	<input type="checkbox"/>	<input type="checkbox"/>	<input type="checkbox"/>
A7	<input type="checkbox"/>	<input type="checkbox"/>	<input type="checkbox"/>	<input type="checkbox"/>	<input type="checkbox"/>	<input type="checkbox"/>	<input type="checkbox"/>
A8	<input type="checkbox"/>	<input type="checkbox"/>	<input type="checkbox"/>	<input type="checkbox"/>	<input type="checkbox"/>	<input type="checkbox"/>	<input type="checkbox"/>

Fluidic specification, connections, norms see previous page.

In case of special application conditions,
 please consult for advice.

Subject to alteration.
 © Christian Bürkert GmbH & Co. KG

1401_EU-en_00895083

DTS 1000106223 EN Version: F Status: RL (released | freigegeben | valide) printed: 18.03.2015